

# Mould Level Gauge

LB 352



# Mould Level Gauge LB 352

The Mould Level Gauge is used to measure the level of molten steel in the moulds.

The measuring system detects the actual level within a measuring range of approx. 100 to 300 mm.

In connection with a downstream control unit and an actuator, automatic casting and fully automated cast-on becomes possible in many continuous casting facilities.

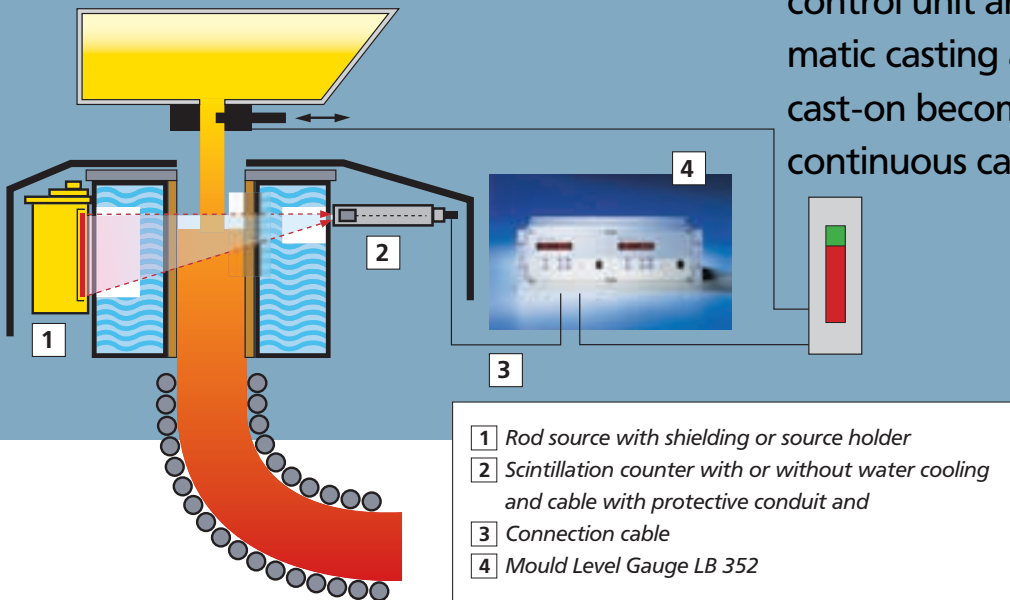

## Advantages

Due to the benefits offered by the principle of measurement used and the well-engineered technique of the device components employed, several thousands of strands have been equipped with Berthold measuring system worldwide. Our system offers the following major advantages:

## Reliability

The principle of measurement works contactless and is unaffected by dust and smoke emission, by the surface condition of the mould level, or by external interventions, e.g. when removing slag.

## Ruggedness

Since the instruments are installed below the mould cover, they are excellently protected against damage, even if trouble occurs in the casting process.

The scintillation detectors used are rather small, so they can easily be protected against thermal, electromagnetic and mechanical influences.

## User-friendliness

Calibration of the instruments during start-up and after a mould change is carried out either manually or automatically at the push of a button.

## Safety

The use of scintillation detectors along with optimum adaptation to the mould construction allows you to work with very low source activities. Suitable shieldings will reduce the dose rates outside the mould cover to a level such that usually the casting personnel do not need to take any personal precautions.

# Adaptation to the Mould Construction

Careful adaptation to the mould construction allows you to keep the source-detector distance fairly short and to reduce the wall thickness to be irradiated. Consequently, a lower source activity will be required and the measurement geometry is optimized.

Depending on the casting format and the mould construction, the following basic arrangements are possible.

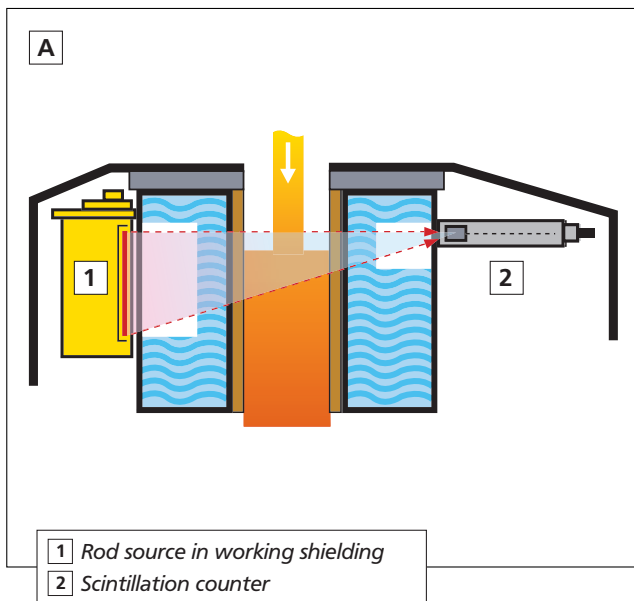

## A. External arrangement

This arrangement is preferably used in mould constructions for **billet casters**.

The source is installed in a lockable shielding. It is installed on the mould outside the water box. The water layer and steel wall thickness can be reduced in the area of the radiation path. Depending on how much space is available, the scintillation detector may be mounted outside or inside the water jacket.

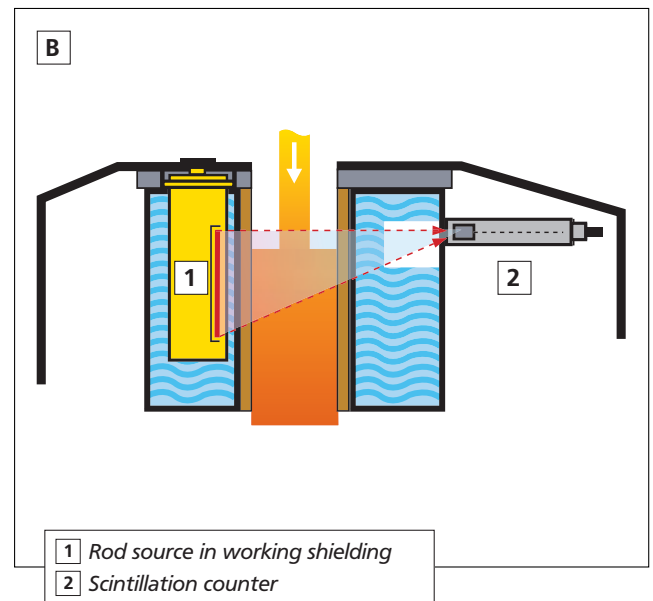

## B. Internal arrangement

This arrangement is used in mould constructions for **bloom or slab casters**.

The source is installed in a lockable shielding. The shielding is mounted in a protection tube inside the water box or the supporting frame of the mould. The steel wall thickness is reduced as much as permissible in the area of the radiation path.



19" rack with 2 channels  
approx. 5.5 kg

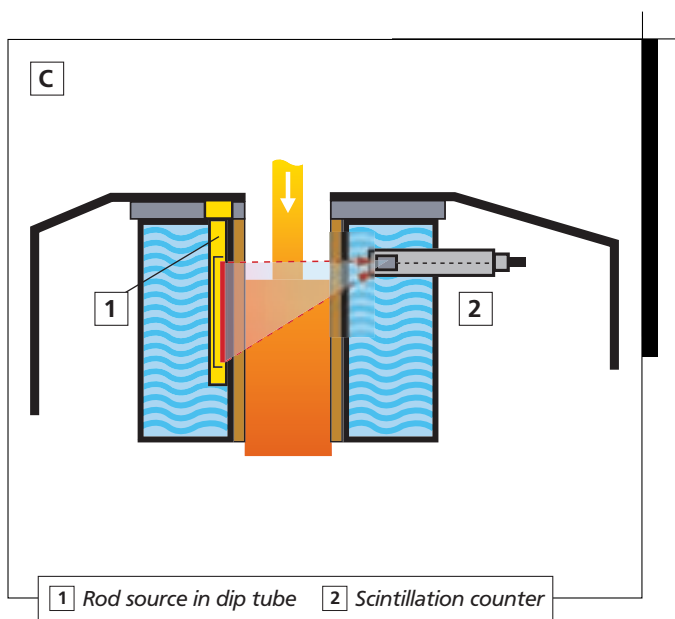

### C. Installation in a protection tube

This type of installation is used when there are **difficult space conditions**, for example on agitators.

The source is installed in a dip tube which is screwed into the water box or the supporting frame construction of the mould. The source is installed and dismantled using a special shielding, which is placed onto the mould above the source installation site.

For subsequent installation, this source arrangement requires the **least modifications**. The required source activities are particularly low, often below 100 MBq.

Scintillation detector  
LB 6639  
without water cooling

Scintillation detector  
LB 6639 W  
with water cooling

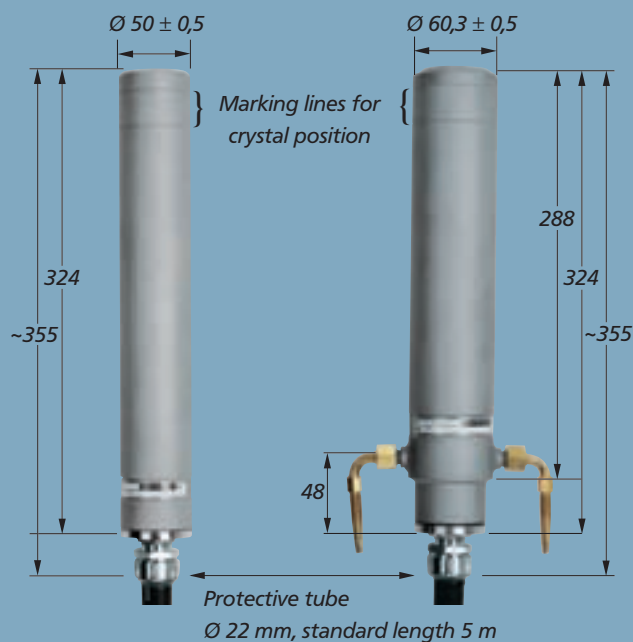

Scintillation detector  
LB 6652  
with water cooling

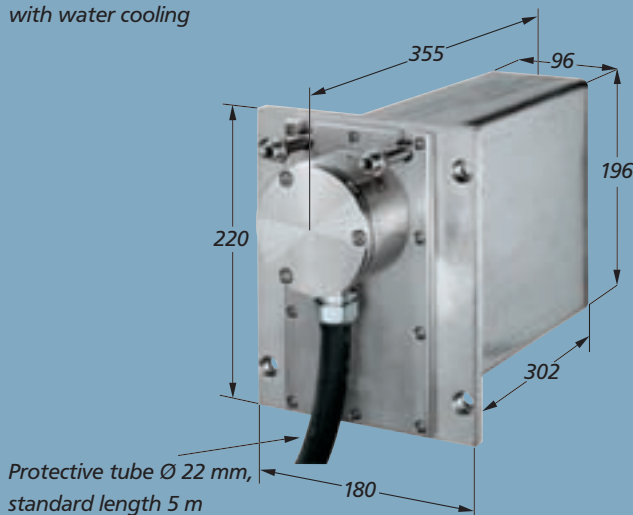

# Contactless Measurement Technique

## Principle of Measurement

The Mould Level Gauge LB 352 operates according to the radiometric principle, utilizing the physical law that Gamma radiation is attenuated as it passes through matter.

Since source type, wall thicknesses and radiation path are constant, the measurement can only be affected by the mould level. All other physical properties, such as temperature, dirt and vapor have no influence.

Since the absorption law follows an exponential curve, the measuring effect with typical mould dimensions becomes practically independent of the interference factors mentioned above.

As a consequence, the radiometric measuring method features a high level of operational safety and requires practically no maintenance, even under difficult operating and ambient conditions. The use of scintillation counters as radiation detectors and careful project engineering ensure that the lowest possible source activities and the best shieldings will be used.

The radiation exposure of the operating staff will clearly stay below the extremely low values permitted by law, which are about as high as the natural environmental radiation.

## Project Engineering

When designing the level gauging system, the special features of the production process and possible contingent conditions should be taken into account, in addition to the actual measuring task. Full information and dimensional drawings should therefore be provided.

- Engineering Data**
- 
- Mould dimensions**
- 
- Casting formats**
- 
- Wall thicknesses of:**
  - Mould
  - Cooling water
  - Water guide plates
  - Housing etc.
- 
- Required measuring range**
- 
- Position of measuring range**
- 
- Casting speed**
- 
- Country of installation**

## Further applications by BERTHOLD TECHNOLOGIES

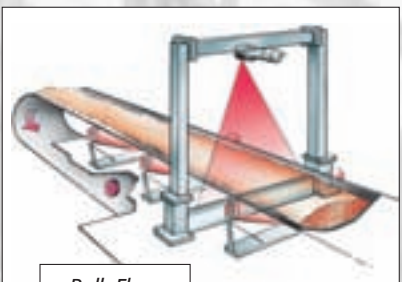

Bulk Flow

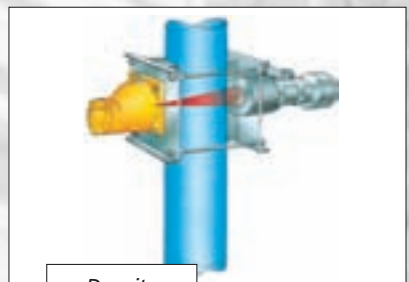

Density

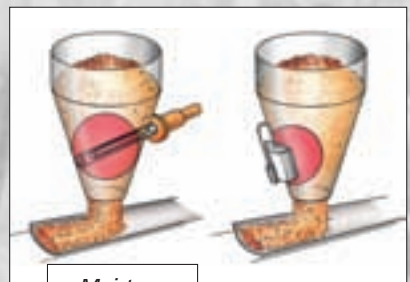

Moisture

# Technical Data LB 352

## Evaluation unit

Design	19" module 3 HE, 21 TE/ protection class IP20
Weight	approx. 2 kg
Power supply	230 V AC +10%/-15% 115 V AC +10%/-15% 18 V to 36 V DC or 24V AC
Power consumption	approx. 15 VA (AC), 15W (DC)
Operating temperature	0 °C to +50 °C (273 to 323 K) no condensation
Storage temperature	-40 °C to +70 °C (233 to 343 K) no condensation
Time constant	0.025 to 99 s
Long time stability	< +/- 1%
Count rate range	0 to 99999 cps
Operation	via foil keyboard
Display	digital via 5-digit luminous digits
Calibration	automatically via push buttons or external calibration
Accuracy	typically approx. +/- 3% of measuring range
Housing	19" rack 3 HE, 84 TE (max. 2 evaluation units)
Weight	5.5 kg
Detector connection	signal transmission
Digital inputs	external calibration full external calibration empty
Current outputs	0/4 to 20 mA for control 0/4 to 20 mA for recording max. 500 Ohm, isolated
Digital outputs	1 relay for error message 1 relay for max. signal 1 relay for min. signal max. 230 V/2A, SPDT, non-inductive

## Detectors

Scintillation counter	stainless steel housing 1.4301
Cable at detector	silicon cable SiHF 7 x 0.5 mm with flexible metal hose
Cable after junction box	7 x 1.5 mm YSLYCY-OZ BE, screened
Maximum cable length	1500 m
Protection type	IP 65
Operating temperature	-20 °C to +50 °C (253 to 323 K) water cooling required at > 50 °C
Storage temperature	-30 °C to +70 °C (243 to 343 K)

## Photomultiplier Version

Used with none or weak magnetic fields

LB 6639	Housing: Ø 50 ± 0.5 x approx. 355 [mm]			
LB 6639 W	Housing: Ø 60.3 ± 0.5 x approx. 355 [mm]			
LB 6652	Housing: 180 (W) x 220 (H) x 355 (D) [mm]			
Type	Scintillator	Dose rate in µSv/h at 3000 l/s	Relative sensitivity	Weight kg
LB 6639 (W)	NAI Ø 25/25	27	1	5
LB 6639 (W)	BGO Ø 25/25	17	1.6	5
LB 6639 (W)	CsI* Ø 40/50	5.1	5.3	7
LB 6639 (W)	CsI* Ø 25/50	8.7	3.1	6
LB 6652	PVT* 50x150x100	0.18	20	23

## Photo Diode Versions

Used with strong magnetic fields

LB 6650	Housing: Ø 50 ± 0.5 x approx. 355 [mm]			
LB 6650 W	Housing: Ø 60.3 ± 0.5 x approx. 355 [mm]			
Type	Scintillator	Dose rate in µSv/h at 3000 l/s	Relative sensitivity	Weight kg
LB 6650 (W)	CsI Ø 25/30	27	1	6
LB 6650 (W)	CsI* Ø 25/40	17	1.6	6
LB 6650 (W)	CsI* Ø 35/50	5.1	2.3	7

## Source and Shieldings

Version and dimension:

project-specific depending on the mould construction



\* Preferred types

Design modifications may occur without notice.

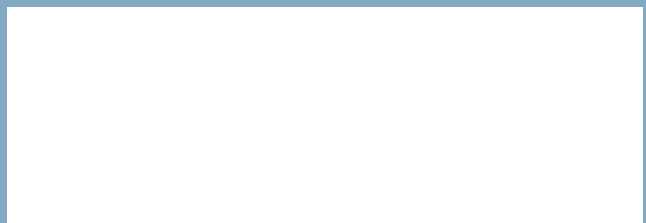

BERTHOLD TECHNOLOGIES GmbH & Co. KG · P.O. Box 100 163 · 75312 Bad Wildbad, Germany  
Phone +49 7081 177-0 · Fax +49 7081 177-100 · industry@Berthold.com · www.Berthold.com